



衍惠电子

AC SOCKET cRU_{US}



DB-14-T-6-S9 2.5A/250Vac & 5A/250Vac

SPECIFICATION



1. Dielectric withstand strength	AC 2000V/1min
2. Insulation resistance	≥100MΩ
3. Operation force	1.5~5kgf
4. Pull force of terminal	60N
5. Solderability test	230±5°C / 3S
6. Soldering heat resistance	260±5°C / 5S
7. Life test	6,000 cycle
8. Heat resistance	80±2°C / 96h
9. Cold resistance	-20±2°C / 96h
10. Salt spray test	24h

DRAWING

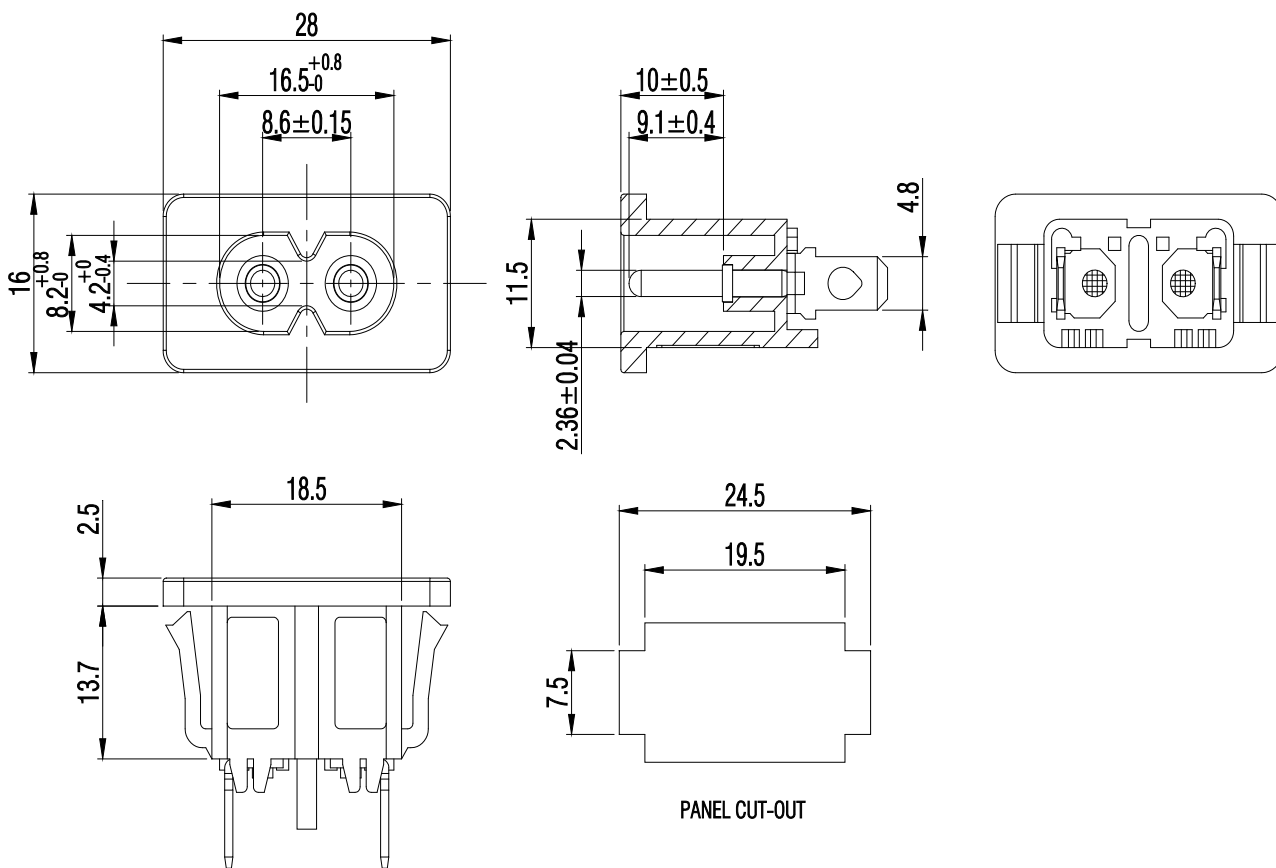

Terminals Type



S1



S9